

## LED DOWNLIGHT ESSENCE



### KEY FEATURES

- Affordable LED alternative for CFL/PLC downlights
- Lifetime 50,000 hours
- Integrated LED driver
- Very quick and easy installation
- Serial connector
- Possible through-wiring
- Excellent price-quality ratio
- Energy savings up to 50%
- 5 years Pragmalux warranty

### APPLICATIONS

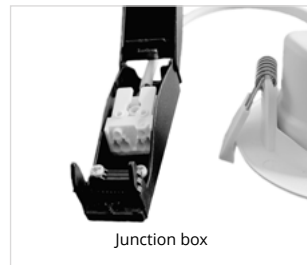

### SPECIFICATIONS

Item code	Description	W	Im	Im/W	Kelvin	CRI	Input current	Lifetime L80B10	Equivalent	Beam angle
4600512	LED Downlight Essence 10W 3000K Ø113mm Cutout Ø90-102mm	10	820	82	3,000	≥80	0.05A	50,000	1x18W PL	100°
4600529	LED Downlight Essence 10W 4000K Ø113mm Cutout Ø90-102mm	10	900	90	4,000	≥80	0.05A	50,000	1x18W PL	100°
4600536	LED Downlight Essence 12W 3000K Ø145mm Cutout Ø120-130mm	12	1,050	88	3,000	≥80	0.06A	50,000	2x18W PL	100°
4600543	LED Downlight Essence 12W 4000K Ø145mm Cutout Ø120-130mm	12	1,100	92	4,000	≥80	0.06A	50,000	2x18W PL	100°
4600550	LED Downlight Essence 17W 3000K Ø174mm Cutout Ø145-155mm	17	1,500	88	3,000	≥80	0.09A	50,000	1x26W PL	100°
4600567	LED Downlight Essence 17W 4000K Ø174mm Cutout Ø145-155mm	17	1,600	94	4,000	≥80	0.09A	50,000	1x26W PL	100°
4600574	LED Downlight Essence 25W 3000K Ø244mm Cutout Ø195-210mm	25	2,230	89	3,000	≥80	0.12A	50,000	2x26W PL	100°
4600581	LED Downlight Essence 25W 4000K Ø244mm Cutout Ø195-210mm	25	2,350	94	4,000	≥80	0.12A	50,000	2x26W PL	100°

### TECHNICAL DATA

Electrical data	
Voltage (V)	220-240
Frequency (Hz)	50/60
Power factor (λ)	≥0.9
Operating mode	Integrated LED Driver
Electrical connection	Max 2x2,5 mm² wire
Total harmonic distortion	≤ 20 %

Certificates & standards	
Driver certificates	CE
Fixture certificates	CE
Ingress protection	IP20
Protection class	II
Protection class IK	03
Glow Wire Test ( IEC 695-2-1)	650°C
Photobiological safety group EN62778	RG0

## Temperatures & operating conditions

Ambient temperature	25°C
Operating temperature	-20 ~ +40°C
Storage temperature	-20 ~ +60°C

## Colors & materials

Color ( Housing)	White ( RAL9016)
Material ( Housing)	PC
Material ( Diffuser)	PC

## Capabilities

UGR	≤25
Dimmable	No
Type of connection	Push Terminal, 2-pole
LED Module replacable	No
Installation	Through-wiring Possible

## SPECIFICATIONS DRIVERS

Item code	Description	Driver failure rate at 5,000h	Inrush current Ipeak	Inrush current Twidth	Max. No. of drivers on MCB Type B 10A	Max. No. of drivers on MCB Type B 16A	Max No. of drivers on MCB Type C 10A	Max. No. of drivers on MCB Type C 16A
4600512	LED Downlight Essence 10W 3000K Ø113mm Cutout Ø90-102mm	≤1%	<15A	200µs	142	228	142	228
4600529	LED Downlight Essence 10W 4000K Ø113mm Cutout Ø90-102mm	≤1%	<15A	200µs	142	228	142	228
4600536	LED Downlight Essence 12W 3000K Ø145mm Cutout Ø120-130mm	≤1%	<15A	200µs	111	177	111	177
4600543	LED Downlight Essence 12W 4000K Ø145mm Cutout Ø120-130mm	≤1%	<15A	200µs	111	177	111	177
4600550	LED Downlight Essence 17W 3000K Ø174mm Cutout Ø145-155mm	≤1%	<15A	200µs	76	1213	76	123
4600567	LED Downlight Essence 17W 4000K Ø174mm Cutout Ø145-155mm	≤1%	<15A	200µs	76	1213	76	123
4600574	LED Downlight Essence 25W 3000K Ø244mm Cutout Ø195-210mm	≤1%	<15A	200µs	55	88	55	88
4600581	LED Downlight Essence 25W 4000K Ø244mm Cutout Ø195-210mm	≤1%	<15A	200µs	55	88	55	88

## DIMENSIONS

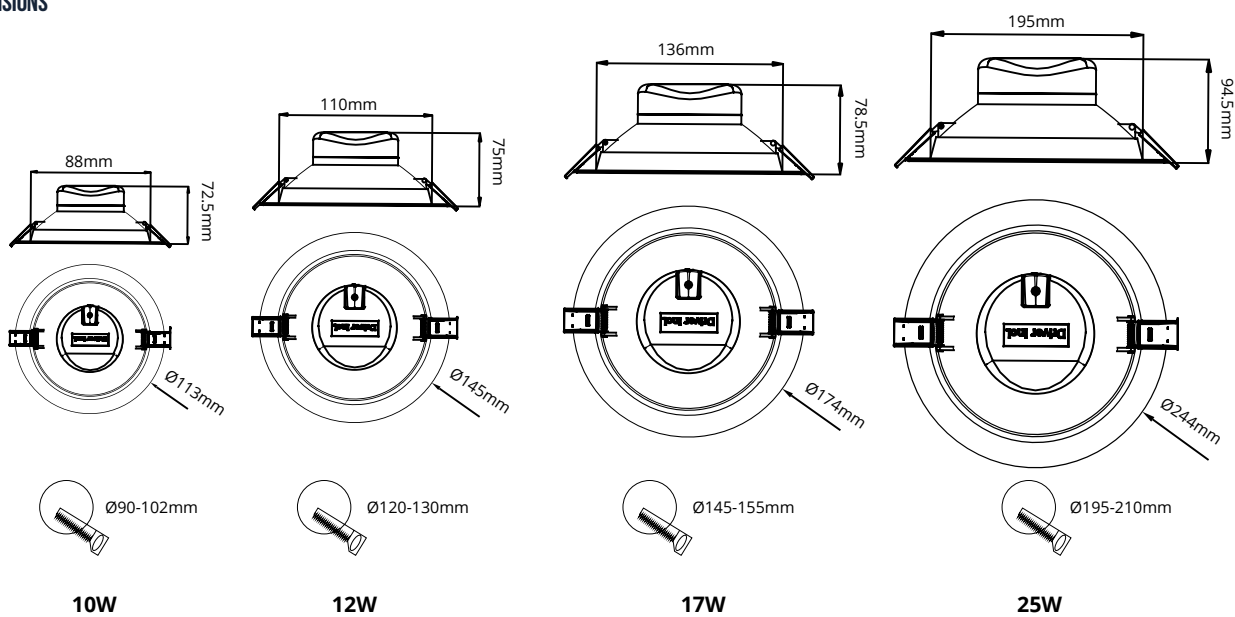

## PRAGMALUX

All rights reserved. Pragmalux - PDL Lighting Group B.V. retains the right to modify product specifications without any prior notice or obligation and does not assume any liability for any consequences of using this document. Subject to errors and printing errors. Luminous flux tolerance: +/- 10%. Power consumption tolerance: +/- 10%.

Version: August 2019

## PHOTOMETRIC SPECIFICATIONS

### LED Downlight Essence 10W 3000K

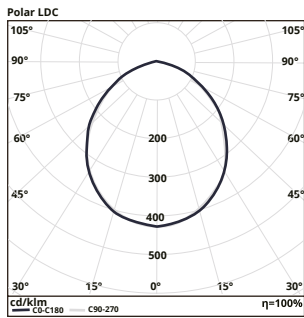

**Cone Diagram**

Distance(m)	Cone Diameter(m)	illuminance(lx)
0.5	1.16 1.20	E(0°) 1294 E(C90) 49.3° 193 E(C0) 50.3° 182
1.0	2.33 2.41	E(0°) 349 E(C90) 49.3° 48 E(C0) 50.3° 45
1.5	3.49 3.61	E(0°) 155 E(C90) 49.3° 21 E(C0) 50.3° 20
2.0	4.65 4.82	E(0°) 87 E(C90) 49.3° 12 E(C0) 50.3° 11
2.5	5.81 6.02	E(0°) 56 E(C90) 49.3° 8 E(C0) 50.3° 7
3.0	6.98 7.23	E(0°) 39 E(C90) 49.3° 5 E(C0) 50.3° 5

### LED Downlight Essence 10W 4000K

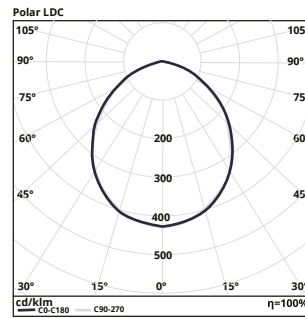

**Cone Diagram**

Distance(m)	Cone Diameter(m)	illuminance(lx)
0.5	1.17 1.20	E(0°) 1525 E(C90) 49.5° 209 E(C0) 50.2° 201
1.0	2.34 2.40	E(0°) 435 E(C90) 49.5° 52 E(C0) 50.2° 50
1.5	3.51 3.60	E(0°) 169 E(C90) 49.5° 23 E(C0) 50.2° 22
2.0	4.68 4.80	E(0°) 95 E(C90) 49.5° 13 E(C0) 50.2° 13
2.5	5.85 6.00	E(0°) 61 E(C90) 49.5° 8 E(C0) 50.2° 8
3.0	7.03 7.20	E(0°) 42 E(C90) 49.5° 6 E(C0) 50.2° 6

### LED Downlight Essence 12W 3000K

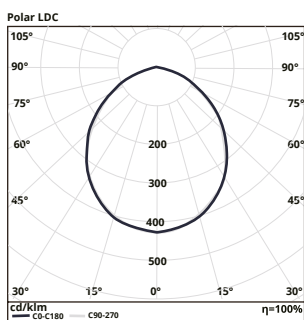

**Cone Diagram**

Distance(m)	Cone Diameter(m)	illuminance(lx)
0.5	1.17 1.23	E(0°) 1756 E(C90) 49.5° 229 E(C0) 51.0° 219
1.0	2.35 2.47	E(0°) 439 E(C90) 49.5° 59 E(C0) 51.0° 55
1.5	3.52 3.70	E(0°) 195 E(C90) 49.5° 27 E(C0) 51.0° 24
2.0	4.70 4.94	E(0°) 110 E(C90) 49.5° 15 E(C0) 51.0° 14
2.5	5.87 6.17	E(0°) 70 E(C90) 49.5° 10 E(C0) 51.0° 9
3.0	7.05 7.41	E(0°) 49 E(C90) 49.5° 7 E(C0) 51.0° 6

### LED Downlight Essence 12W 4000K

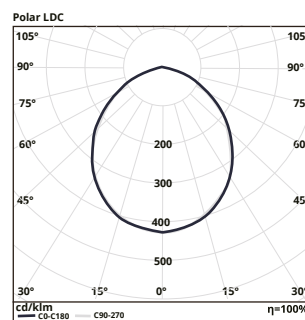

**Cone Diagram**

Distance(m)	Cone Diameter(m)	illuminance(lx)
0.5	1.23 1.15	E(0°) 1839 E(C90) 50.8° 232 E(C0) 48.9° 262
1.0	2.45 2.29	E(0°) 460 E(C90) 50.8° 58 E(C0) 48.9° 65
1.5	3.68 3.44	E(0°) 204 E(C90) 50.8° 26 E(C0) 48.9° 29
2.0	4.90 4.59	E(0°) 115 E(C90) 50.8° 15 E(C0) 48.9° 16
2.5	6.13 5.73	E(0°) 74 E(C90) 50.8° 9 E(C0) 48.9° 10
3.0	7.36 6.88	E(0°) 51 E(C90) 50.8° 6 E(C0) 48.9° 7

### LED Downlight Essence 17W 3000K

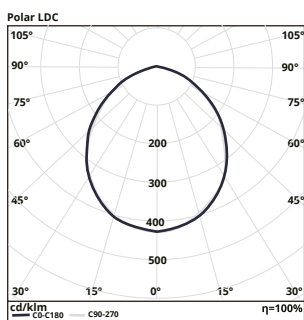

**Cone Diagram**

Distance(m)	Cone Diameter(m)	illuminance(lx)
0.5	1.21 1.34	E(0°) 2492 E(C90) 50.4° 324 E(C0) 51.1° 309
1.0	2.42 2.68	E(0°) 623 E(C90) 50.4° 81 E(C0) 51.1° 77
1.5	3.63 3.72	E(0°) 277 E(C90) 50.4° 36 E(C0) 51.1° 34
2.0	4.84 4.96	E(0°) 156 E(C90) 50.4° 20 E(C0) 51.1° 19
2.5	6.04 6.20	E(0°) 100 E(C90) 50.4° 13 E(C0) 51.1° 12
3.0	7.25 7.44	E(0°) 69 E(C90) 50.4° 9 E(C0) 51.1° 9

### LED Downlight Essence 17W 4000K

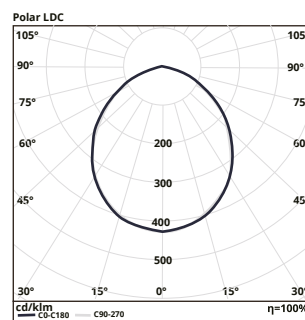

**Cone Diagram**

Distance(m)	Cone Diameter(m)	illuminance(lx)
0.5	1.21 1.23	E(0°) 2690 E(C90) 50.5° 342 E(C0) 51.0° 332
1.0	2.43 2.47	E(0°) 665 E(C90) 50.5° 86 E(C0) 51.0° 83
1.5	3.66 3.70	E(0°) 296 E(C90) 50.5° 38 E(C0) 51.0° 37
2.0	4.85 4.94	E(0°) 166 E(C90) 50.5° 21 E(C0) 51.0° 21
2.5	6.07 6.17	E(0°) 106 E(C90) 50.5° 14 E(C0) 51.0° 13
3.0	7.28 7.41	E(0°) 74 E(C90) 50.5° 10 E(C0) 51.0° 9

### LED Downlight Essence 25W 3000K

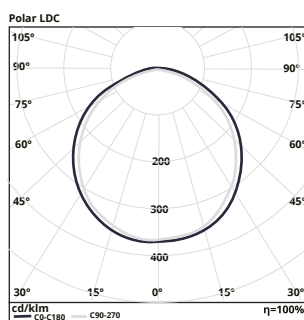

**Cone Diagram**

Distance(m)	Cone Diameter(m)	illuminance(lx)
0.5	1.25 1.51	E(0°) 3396 E(C90) 53.4° 352 E(C0) 56.5° 279
1.0	2.69 3.02	E(0°) 827 E(C90) 53.4° 88 E(C0) 56.5° 70
1.5	4.04 3.53	E(0°) 367 E(C90) 53.4° 39 E(C0) 56.5° 31
2.0	5.39 6.04	E(0°) 207 E(C90) 53.4° 22 E(C0) 56.5° 17
2.5	6.73 7.55	E(0°) 132 E(C90) 53.4° 14 E(C0) 56.5° 11
3.0	8.08 9.07	E(0°) 92 E(C90) 53.4° 10 E(C0) 56.5° 8

### LED Downlight Essence 25W 4000K

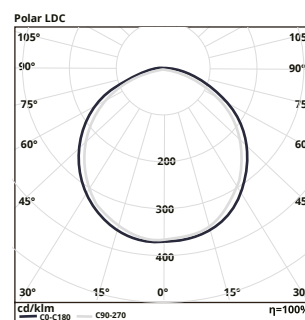

**Cone Diagram**

Distance(m)	Cone Diameter(m)	illuminance(lx)
0.5	1.36 1.40	E(0°) 3599 E(C90) 53.7° 373 E(C0) 54.4° 355
1.0	2.72 2.79	E(0°) 900 E(C90) 53.7° 93 E(C0) 54.4° 89
1.5	4.08 4.19	E(0°) 400 E(C90) 53.7° 41 E(C0) 54.4° 39
2.0	5.45 5.59	E(0°) 225 E(C90) 53.7° 23 E(C0) 54.4° 22
2.5	6.81 6.98	E(0°) 144 E(C90) 53.7° 15 E(C0) 54.4° 14
3.0	8.17 8.38	E(0°) 100 E(C90) 53.7° 10 E(C0) 54.4° 10

## PRAGMALUX

All rights reserved. Pragmalux - PDL Lighting Group B.V. retains the right to modify product specifications without any prior notice or obligation and does not assume any liability for any consequences of using this document. Subject to errors and printing errors. Luminous flux tolerance: +/- 10%. Power consumption tolerance: +/- 10%.

## PACKAGING INFORMATION

Item code	Description	Single box		Master carton		
		Dimensions(LxWxH) (mm)	Weight(kg)	Units per master carton	Dimensions(LxWxH) (mm)	Weight(kg)
4600512	LED Downlight Essence 10W 3000K Ø113mm Cutout Ø90-102mm	150X113X113	0.195	40	475X420X255	8.7
4600529	LED Downlight Essence 10W 4000K Ø113mm Cutout Ø90-102mm	150X113X113	0.195	40	475X420X255	8.7
4600536	LED Downlight Essence 12W 3000K Ø145mm Cutout Ø120-130mm	145X145X81	0.285	40	605X430X320	12.3
4600543	LED Downlight Essence 12W 4000K Ø145mm Cutout Ø120-130mm	145X145X81	0.285	40	605X430X320	12.3
4600550	LED Downlight Essence 17W 3000K Ø174mm Cutout Ø145-155mm	175X175X82	0.37	40	735X370X445	16.5
4600567	LED Downlight Essence 17W 4000K Ø174mm Cutout Ø145-155mm	175X175X82	0.37	40	735X370X445	16.5
4600574	LED Downlight Essence 25W 3000K Ø244mm Cutout Ø195-210mm	246X246X98	0.63	20	525X525X510	14
4600581	LED Downlight Essence 25W 4000K Ø244mm Cutout Ø195-210mm	246X246X98	0.63	20	525X525X510	14

## APPLICATIONS

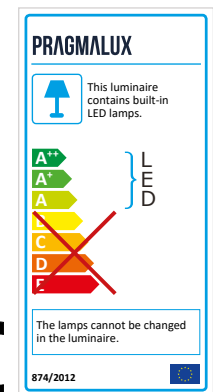

## PRAGMALUX

All rights reserved. Pragmalux - PDL Lighting Group B.V. retains the right to modify product specifications without any prior notice or obligation and does not assume any liability for any consequences of using this document. Subject to errors and printing errors. Luminous flux tolerance: +/- 10%. Power consumption tolerance: +/- 10%.

Version: August 2019